

# MIPRO®

## User Guide

### ACT-70H / ACT-71Ha ACT-71H / ACT-72H Handheld Transmitter



**MIPRO®**  
MICROPHONE PROFESSIONALS

**MIPRO Electronics Co., Ltd**  
Headquarters : 814 Pei-Kang Road, Chiayi, 60096, Taiwan  
Tel : +886.5.238.0809 Fax : +886.5.238.0803  
www.mipro.com.tw mipro@mipro.com.tw

All rights reserved. MN 016/01

Do not copy or forward without prior approvals MIPRO.

Specifications and design subject to change without notice.



2 CE524 C

## Contents

- 1 Handheld Controls and Indicators
- 3 Operating Instructions for Insertion & Removing Battery
- 4 Patented Protection Cover
- 6 LCD Display Screen
- 7 How to Setup Transmitter Parameters
- 12 Battery Status
- 14 MUTE Mode Setting
- 15 General Tips for Improving System Performance

## Handheld Controls and Indicators

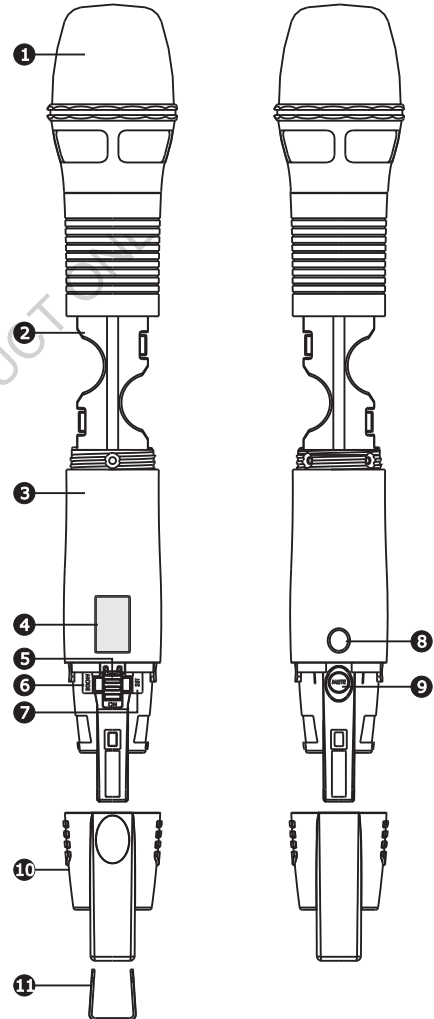

- ❶ **Capsule Module:** Protects detachable microphone capsule module and internal foam prevents breathing, wind and POP noises.
- ❷ **Battery Compartment:** Holds 2 'AA' batteries.
- ❸ **Housing:** Protects transmitter PCB, battery compartment and batteries.
- ❹ **LCD Panel:** Displays transmitter parameters.
- ❺ **Power On/Off Switch:** Slides the power switch to the "ON" position for use or to the "OFF" position when not in use.
- ❻ **MODE Button:** Allows access to available functions displaying in LCD panel.
- ❼ **SET Button:** Parameter selection button.
- ❽ **ACT Infrared (IR) Port:** Receives signals from receiver to synchronize frequencies.
- ❾ **MUTE Button:** To mute and un-mute the audio signal temporary.
- ❿ **Protection Cover:** Protects power switch and prevents user has direct access to power switch.
- ⓫ **Channel ID Clip:** For channel identification (Optional)

## Operating Instructions for Insertion & Removing Battery

- Turn the microphone housing and pull it toward capsule grille to expose battery compartment.
- Insert two new AA alkaline batteries in the battery compartment with correct polarity orientation.
- Turn power switch to ON position after battery installation. If LCD does not lit, please check battery polarity or change to fresh batteries.

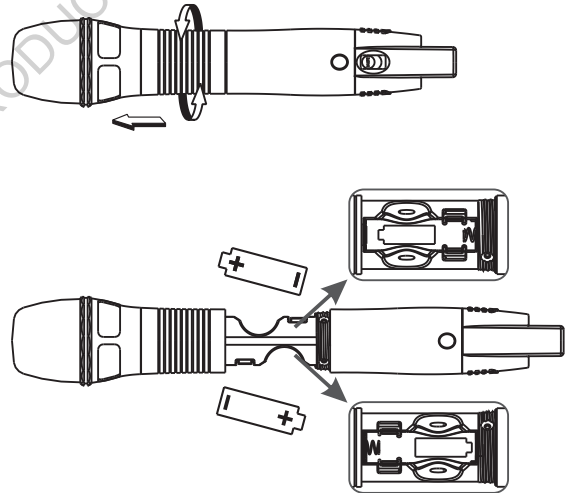

### Caution

Remove the batteries if unused for a long period of time to prevent battery leakage, corrosion and causes damage to electronics.

## Patented Protection Cover

Protection cover's patented design protects accidental access to power switch and its rugged material and snug fit offer protection to both power switch and PCB during accidental drop.

### Steps:

- Remove protection cover and Reverse protection cover.

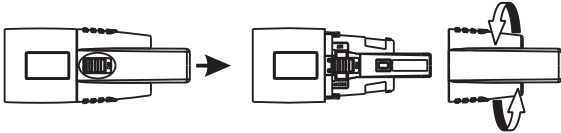

- Install protection cover to protect accidental power on/off.

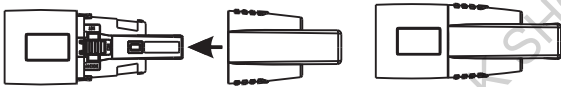

Mute function is open for easy access.

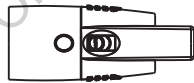

- When power is off, reverse-installation of protection cover will turn on the switch automatically. To turn off the system, remove the cover to turn off.
- Protection cover must be attached during operation for full protection.

- Color-coded channel identification clip can be attached to the bottom of protection cover.

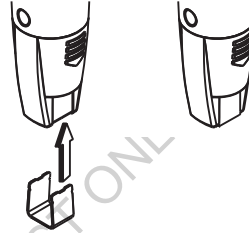

## LCD Display Screen



- A1** LCD Screen for Function Display
- A2** Parameters Screen
- A3** Transmitter Battery Meter

## How to Setup Transmitter Parameters

- Remove protection cover to expose MODE button and SET button.
- **MODE Button**  
Press "MODE" button to access one of the five functions below.
- **SET Button**  
Press "SET" button and LCD will start flashing. During flashing, press SET button to change parameters.

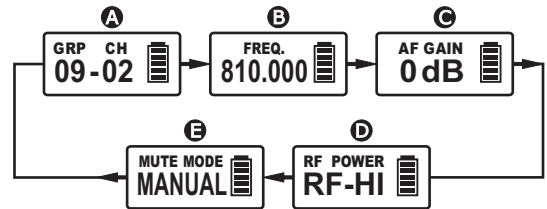
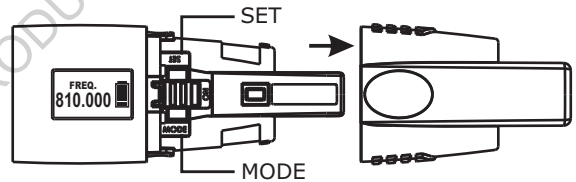

- A** Group and Channel
- B** Frequency
- C** Sensitivity Level
- D** RF Output Power
- E** MUTE Mode

- **Group & Channel** and **Frequency** are factory pre-set, thus, its parameter values are displayed after it is ACT synced. Values cannot be changed.



(Group and Channel)



(Frequency)

### Setting Input Gain Level

- Selectable AF GAIN between 6dB to -6dB with 3dB parameter up or down selection.
- Press MODE button until **AF GAIN** mode appears.
- Press SET button once to activate function.
- Press SET button to select the desired sensitivity level.
- Press MODE button to confirm and save the change.
- The higher the sensitivity level, the lower the dynamic range of input signals. Meanwhile noise will increase, and the feedback problem will be getting more serious.
- Please make sure sensitivity level is set at proper level.



## Setting RF Output Power

- 2 RF Output Power Levels: RF-HI and RF-LOW.
- Press MODE button until **RF POWER** mode appears.
- Press SET button once to activate function.
- Press SET button to select the desired RF output power.
- Press MODE button to confirm and save the change, or LCD will stop flashing and parameter will be saved.

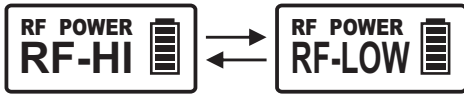

## MUTE MODE

- MUTE MODE: Select from MANUAL and DISABLE.
- Press MODE button until **MUTE MODE** appears. Press SET button once, the LCD screen starts flashing to denote it is ready to accept mode changes. Press SET button to change between MANUAL and DISABLE in cycle. Press MODE button to confirm and save the change, or LCD will stop flashing and parameter will be saved.
- MUTE button is operable when MUTE MODE is set in MANUAL mode.
- MUTE button is not operable when MUTE MODE is set in DISABLE mode.

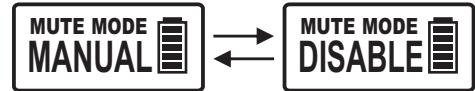

## Battery Status

- When the battery has less than 10% power remaining, display will start flashing and batteries must be replaced immediately. If an under voltage condition continues, the LCD will show "**OFF...**" and the system will shut down.

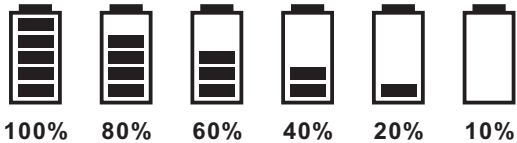

## Power Button

- Turn the power switch to **ON** position where transmitter will be activated and LCD will lit up.
- Turn the power switch to **OFF** position to shut down the transmitter.
- When the power switch is turned off, the LCD will show "**OFF...**" (for Power,Off) first and then the system will shut down and no further messages will be displayed.

**OFF...**

## ERR Message

- When "ERR" appears in the display it indicates that an operational error has occurred. Please refer to the following codes to diagnose which error you are experiencing.
  - ERR no01** EEPROM is not being programmed or internal data error.
  - ERR no02** For testing only.
  - ERR no03** The frequency you want to program is above the switching bandwidth of the transmitter. Use a receiver with an appropriate frequency group. (At this time the microphone is still operating and the frequency remains unchanged. To clear the displayed "ERR" message, switch the handheld transmitter off and on again.)
  - ERR no04** The frequency you want to program is below the switching bandwidth of the transmitter. Use a receiver with an appropriate frequency group. (At this time the microphone is still operating and the frequency remains unchanged. To clear the displayed "ERR" message, switch the handheld transmitter off and on again.)
- "Group" & "Channel":** When both the group and channel numbers are displayed, it means that you are using the pre-programmed frequency of the receiver.
- "Channel" Only:** If "Channel" only is displayed, it means that you are using a frequency which is not pre-programmed.



## MUTE Mode Setting

- Press MUTE button once to MUTE audio.  
"MUTE" appears.
- Press MUTE button again to UNMUTE audio  
"UNMUTE" appears.
- MUTE button is operable when MUTE MODE is set in MANUAL mode.

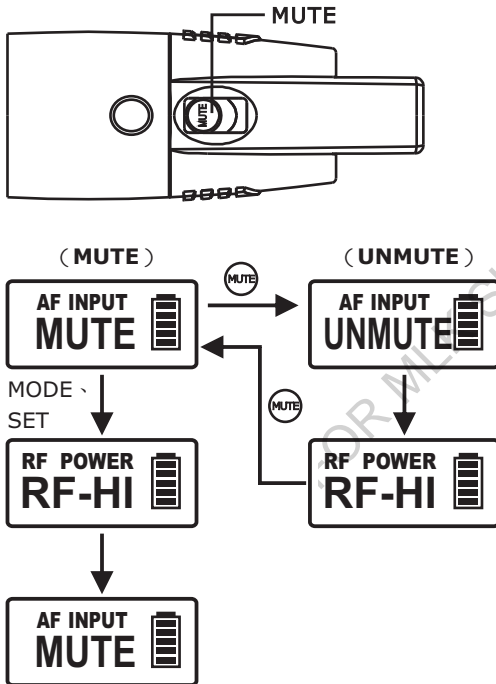

## General Tips for Improving System Performance

1. Performer should avoid holding the microphone over or near the antenna section as this will deteriorate transmission efficiency. Severe deterioration if performer directly covers up the antenna section with both hands.
2. Many performers tend to hold the microphone by the top grille. Unfortunately, this position seriously degrades both the sound quality and directionality of a microphone. Even the most expensive microphones will have its original sound quality compromised by this method. Grabbing a microphone by the grille will isolate the capsule's acoustic resonance circuit and or change the capsule resonator's frequency. This results in an inferior performance in both frequency response and the separation of directionality. In addition, a palm's sound-focusing effect will tend to strengthen resonances in certain frequencies and can cause unwanted echo.
3. A proper technique is required for using directional microphones because the distance between the microphone and your mouth has a significant impact on sensitivity and performance. There is an inverse relationship between microphone sensitivity and the distance from the mouth to the microphone. Consequently, performers with a "weaker" sound level cannot expect to hold the microphone too far away from their mouth and compensate by turning up the amplifier volume to increase the sound level as this can easily cause echo or feedback. In contrast, performers with a "louder" sound level should not hold the microphone too close as this can easily result in distortion by causing the amplifier system to be overloaded.

4. Furthermore, a large-diaphragm directional microphone has a very distinct proximity effect. When the microphone is close to the mouth, the bass response is strengthened as the distance gets closer. Therefore, if a performer's sound is insufficient in bass, they can hold the microphone closer and use the proximity effect to help compensate for the lower bass level. Conversely, if a performer's voice is too heavy in the bass register, increasing the distance between the microphone and their mouth will decrease the proximity effect and reduce the bass response, thus making their voice become clearer and brighter.
5. It is recommended to keep the grille and sponge windscreen clean to avoid any substance blocking the proximity effect of the microphone.

#### Notes

1. Refer to actual product in the event of product description discrepancy.
2. Frequency range and maximum deviation comply with the regulations of different countries.

#### Federal Communication Commission Interference Statement

This equipment has been tested and found to comply with the limits for a Class B digital device, pursuant to Part 15 of the FCC Rules. These limits are designed to provide reasonable protection against harmful interference in a residential installation. This equipment generates, uses and can radiate radio frequency energy and, if not installed and used in accordance with the instructions, may cause harmful interference to radio communications. However, there is no guarantee that interference will not occur in a particular installation. If this equipment does cause harmful interference to radio or television reception, which can be determined by turning the equipment off and on, the user is encouraged to try to correct the interference by one of the following measures:

- Reorient or relocate the receiving antenna.
- Increase the separation between the equipment and receiver.
- Connect the equipment into an outlet on a circuit different from that to which the receiver is connected.
- Consult the dealer or an experienced radio/TV technician for help.

*FCC Caution:* To assure continued compliance, any changes or modifications not expressly approved by the party responsible for compliance could void the user's authority to operate this equipment. (Example - use only shielded interface cables when connecting to computer or peripheral devices).

#### *FCC Radiation Exposure Statement*

This equipment complies with FCC RF radiation exposure limits set forth for an uncontrolled environment. This equipment should be installed and operated with a minimum distance of 0.5 cm between the radiator and your body.

This transmitter must not be co-located or operating in conjunction with any other antenna or transmitter.

The antennas used for this transmitter must be installed to provide a separation distance of at least 0.5 cm from all persons and must not be co-located or operating in conjunction with any other antenna or transmitter.

This device complies with Part 15 of the FCC Rules.

Operation is subject to the following two conditions:

- (1) This device may not cause harmful interference, and
- (2) This device must accept any interference received, including interference that may cause undesired operation.

## IC

This device complies with Industry Canada RSS-210

ISSUE 2 standards. Operation is subject to the following two conditions:

- (1) this device may not cause interference, and
- (2) this device must accept any interference, including interference that may cause undesired operation of the device.

Le présent appareil est conforme aux CNR d'Industrie Canada applicables aux appareils radio exempts de licence.

L'exploitation est autorisée aux deux conditions suivantes:

- (1) l'appareil ne doit pas produire de brouillage, et
- (2) l'utilisateur de l'appareil doit accepter tout brouillage radioélectrique subi, même si le brouillage est susceptible d'en compromettre le fonctionnement.

## WARNING

### 1. FOR OUTDOOR USE:

To reduce the risk of fire or electric shock, do not expose this apparatus to rain or moisture.

### 2. UNDER WET LOCATION:

Apparatus should not be exposed to dripping or splashing and no objects filled with liquids, such as vases should be placed on the apparatus.

### 3. SERVICE INSTRUCTIONS:

CAUTION - These servicing instructions are for use by qualified service personnel only. To reduce the risk of electric shock, do not perform any servicing other than that contained in the operating instructions unless you are qualified to do so.



 This symbol indicates that dangerous voltage constituting a risk of electric shock is present within this unit.

 This symbol indicates that there are important operating and maintenance instructions in the literature accompanying this unit.

## Disposal

Dispose of any unusable devices or batteries responsibly and in accordance with any applicable regulations.



2005-08-19

Disposing of used batteries with domestic waste is to be avoided!

Batteries / NiCad cells often contain heavy metals such as cadmium(Cd), mercury(Hg) and lead(Pb) that makes them unsuitable for disposal with domestic waste. You may return spent batteries/accumulators free of charge to recycling centres or anywhere else batteries/accumulators are sold.

By doing so, you contribute to the conservation of our environment!